

# SAMPLE APPROVAL SHEET

## 產品規格承認書

Company Name

(客戶名稱)

\_\_\_\_\_

Part Number

(產品型號)

SMD0603NG

\_\_\_\_\_

Sample Quantity

(樣品數量)

\_\_\_\_\_

Sample Date

(送樣日期)

\_\_\_\_\_

Approved

(供應商確認)

\_\_\_\_\_

Approved

(客戶確認)

\_\_\_\_\_

## BRIEF INTRODUCTION

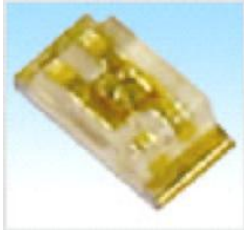

1. Chip LED.
2. Super Compact Type.
3. Dimension: 1.6x0.8x0.68(mm).
4. View Angle  $\geq 160^\circ$ .
5. Application: Display, Moving Sign, Backlight Panel.
6. All Emitting Color Available.

## PACKAGE OUTLINE DRAWING

(Unit: mm Tolerance: +/- 0.1)

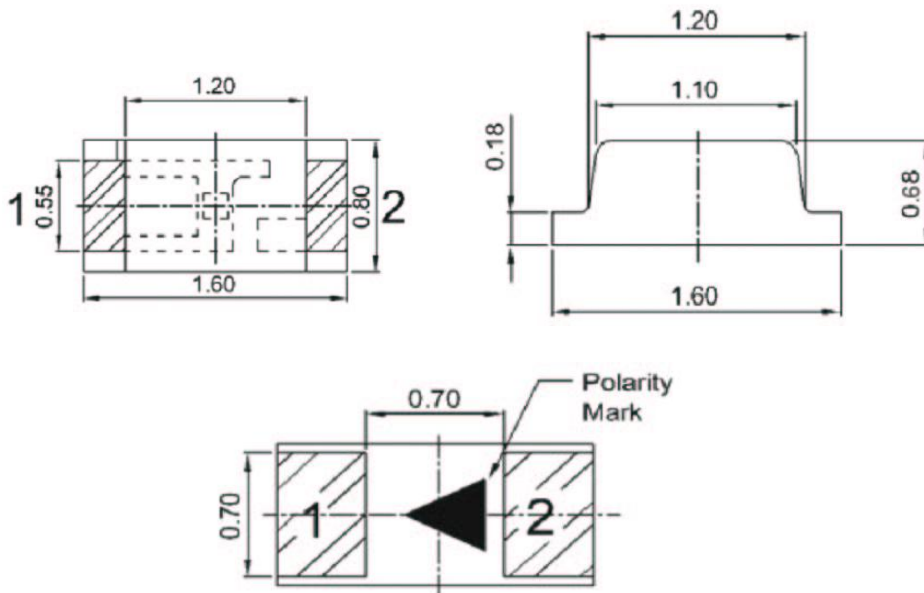

## LIGHT RADIATION PATTERN

(Vertical / Horizontal)

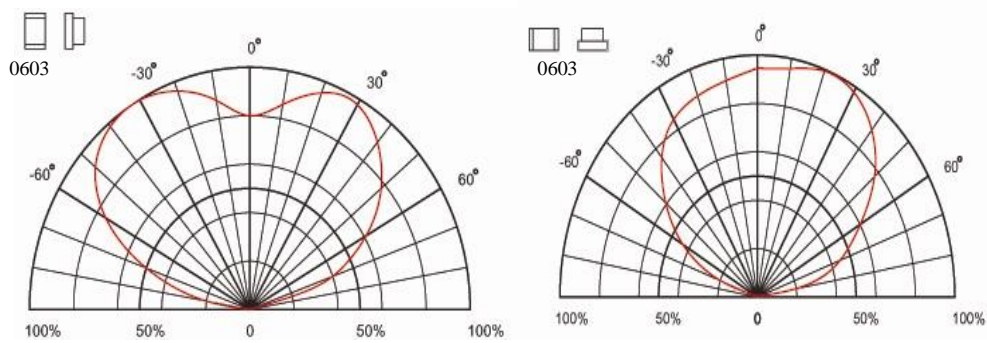

**ABSOLUTE MAXIMUM RATINGS**(T<sub>A</sub>=25°C)

ITEM	SYMBOL	VALUE	UNIT
Power Dissipation	P <sub>D</sub>	72	mW
DC Forward Current	I <sub>F</sub>	30	mA
Pulsed Forward Current	I <sub>FP</sub>	100	mA
Reverse Voltage (I <sub>R</sub> =100 μA)	V <sub>R</sub>	5	V
Operating Temperature	T <sub>OP</sub>	-30 TO 80	°C
Storage Temperature	T <sub>ST</sub>	-40 TO 85	°C

**ELECTRICAL-OPTICAL CHARACTERISTICS**T<sub>A</sub>=25°C)

Code for parts	Forward Voltage(V)		Wavelength (nm)	Luminous Intensity (mcd) *	I <sub>f</sub> (mA)
	Min	max			
SMD0603NG	2.8	3.4	515 ~ 525	200~300	20

\*Per NIST Standards

Forward Current vs. Ambient Temperature

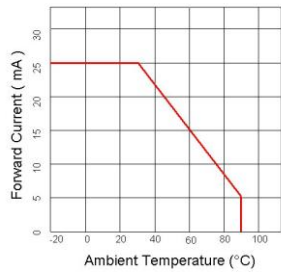

Forward Voltage vs. Forward Current

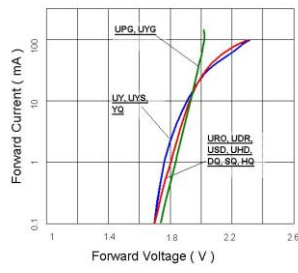

Relative Intensity vs. Forward Current

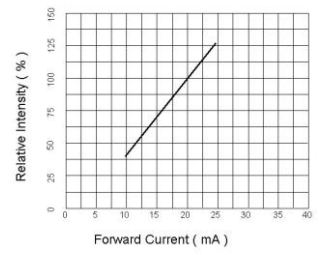

Relative Intensity vs. Ambient Temperature  
Pulsed 20mA, 300us pulse, 10ms period

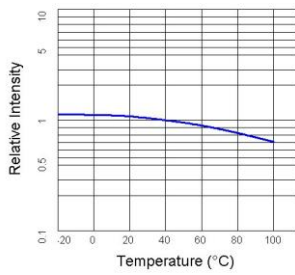

Relative Intensity vs. Wavelength

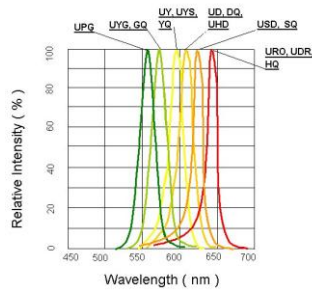

## CAUTIONS OF APPLICATION (Assembly)

### 1) Soldering

#### 1.1) Manual soldering (We do not recommend this method strongly.)

- 1.1.1) Soldering tin material: tin 6/4 alloy or contained Ag.
- 1.1.2) To prevent cracking, please bake before manual soldering.
- 1.1.3) Keep the temperature on the edge of iron at  $300 \pm 5^\circ\text{C}$  Max. (25W) and apply for 3 Seconds. If the temperature becomes higher, apply in a shorter time (1 sec per  $10^\circ\text{C}$ ).
- 1.1.4) In manual soldering, take care not to damage the package especially terminal or resin. (Do not give stress to the product when soldering.)
- 1.1.5) Do not use again if you remove the soldered product.
- 1.1.6) It is recommended using an iron with a temperature control.

#### 1.2) Reflow Soldering

- 1.2.1) Recommend tin glue specifications:
  - a) Melting temperature:  $178 \sim 192^\circ\text{C}$
  - b) Contains: Sn 63%, Pb 37%
- 1.2.2) Never take next process until the component is cooled down to room temperature after reflow.
- 1.2.3) The recommended reflow soldering profile (measuring on the surface of the LED resin) is following:

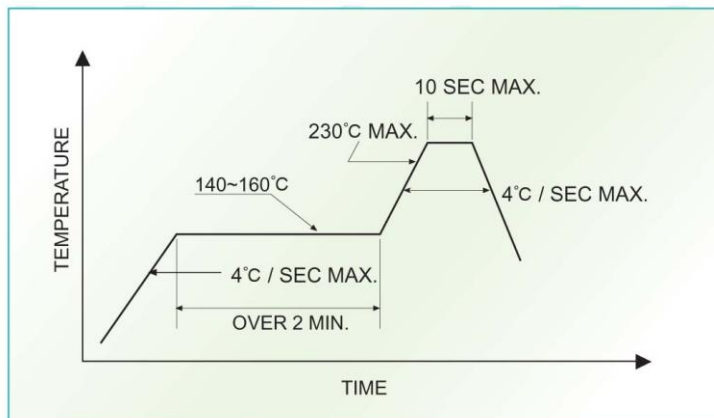

#### 1.3) Rework

- 1.3.1) Customer must finish rework within 5 sec under  $260^\circ\text{C}$ .
- 1.3.2) The head of iron cannot touch copper foil.
- 1.3.3) Twin-head type is preferred.

#### 1.4) Cleaning

The conditions of cleaning after soldering:

- 1.4.1) An alcohol-based solvent such as Isopropyl Alcohol (IPA) is recommended.
- 1.4.2) Temperature X Time:  $< 50^\circ\text{C} \times 30\text{sec}$ , or  $< 30^\circ\text{C} \times 3\text{min}$
- 1.4.3) Ultra sonic cleaning:  $< 15\text{W} / \text{bath}$ ; Bath volume: 1liter max.

1.4.4) Curing: 100°C max, < 3min

### 1.5)Cautions of Pick and Place

1.5.1) It should be avoided to load stress on the resin during high temperature.

1.5.2) Avoid rubbing or scraping the resin by any object.

1.5.3) Electric-static may cause damage to the component. Please confirm that the equipment is grounding well. Using an ionizer fan is recommended.

### 1.6)Cautions of Design and Applications

1.6.1) It should be done to connect with a current-limiting serial resistor. Avoid to drive reverse voltage over the specifications on LED when ON/OFF.

1.6.2) Any application should refer to the specifications of absolute maximum ratings.

1.6.3) The dimensions of the recommended soldering pattern may not meet every user.

Please confirm and study first before designing the soldering pattern in order to obtain the best performance of soldering.

1.6.4) Do not contact with any component on the assembly board.

### RECOMMENDED SOLDER PAD

(Unit: mm Tolerance: +/- 0.1)

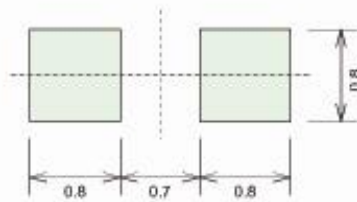

### CARRIER TAPE DIMENSIONS

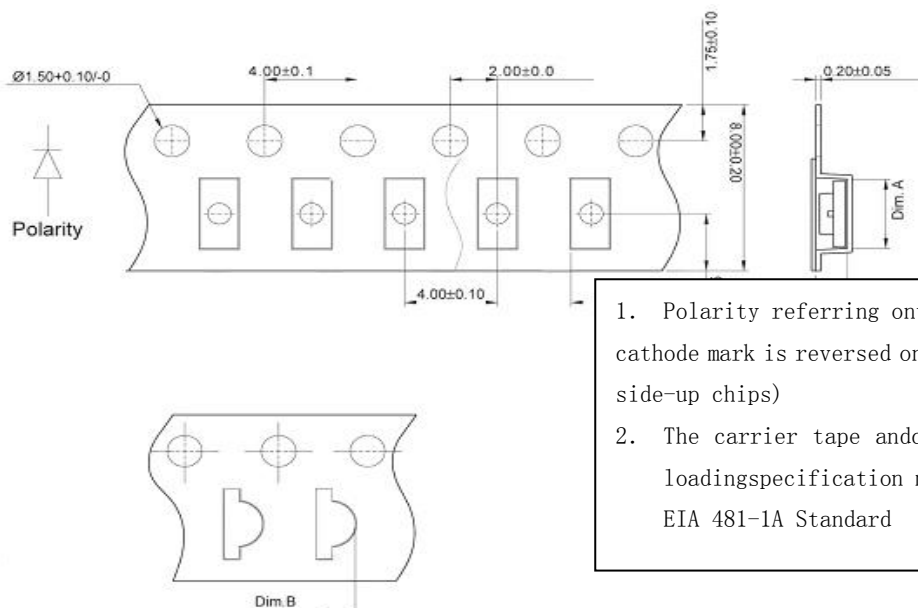

1. Polarity referring onto the cathode mark is reversed on the UR (N side-up chips)
2. The carrier tape and components loadingspecification meet the EIA 481-1A Standard

Part No	Dim.A	Dim.B	Dim.C	Q'ty/Reel
SMD0603	1.80±0.10	0.95±0.10	0.75±0.10	4K

Tape Leader and Trailer Dimensions

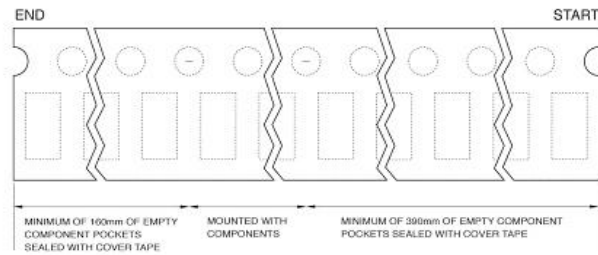

### Plastic Reel Dimensions

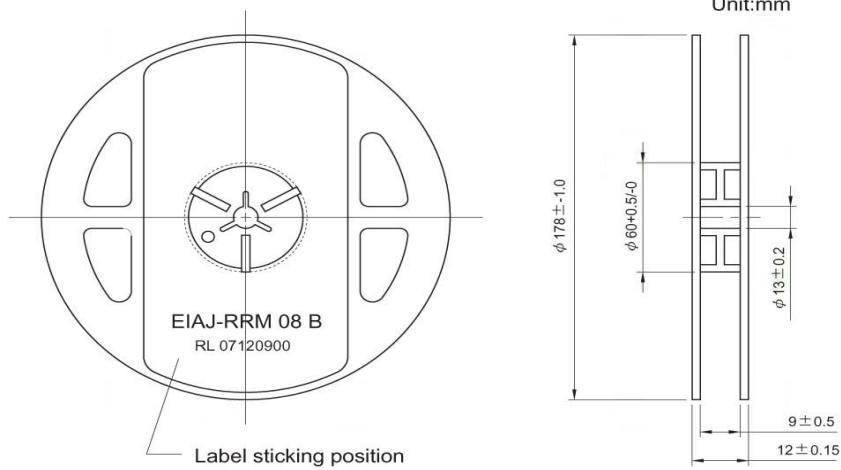

### Reel Box and Shipping Carton

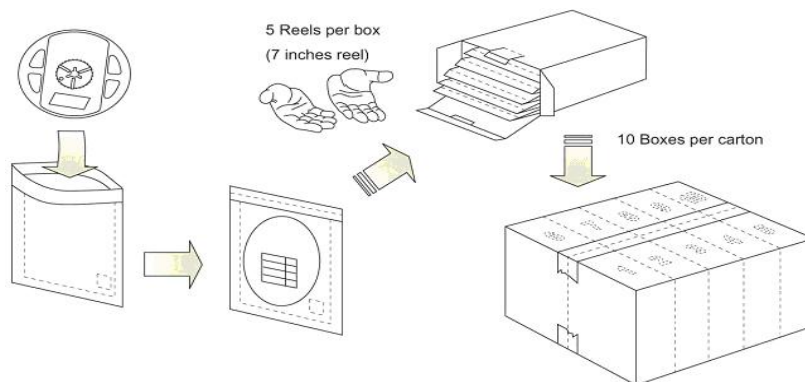

### Cautions of Application

## 1) Dry Pack

1.1) Avoid absorbing moisture at any time of transportation or storage.

1.2) Every reel will be packaged in the moisture barrier anti-static bag (Specific bag material will depend upon customer's requirement or selection). And the bag is well sealed before shipment.

1.3) The package is the following:

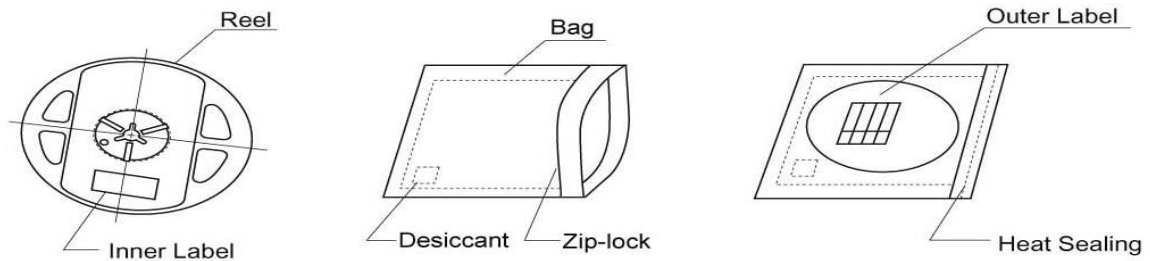

## 2) Storage

2.1) It's recommended to store the products in the following conditions:

Humidity: 60 %RH Max. Temperature: 5°C~30°C (41°F ~86°F)

2.2) Shelf life in sealed bag: 12 month at <40°C and <90%RH.

2.3) After the bag is opened, devices that will be subjected to infrared reflow, vapor-phase reflow, or equivalent processing must be: Mounted within 1 year at factory conditions of 30°C /60% RH, or Stored at  $\leq 20\%$  RH with zip-lock sealed.

## 3) Baking

It's recommended to baking before soldering when the pack is unsealed after 15 days. The conditions are as followings:

- a) 60±3°C (12~24hrs) and < 5% RH, taped reel type
- b) 100±3°C (45min~1hr), bulk type
- c) 130±3°C (15~30min), bulk type

\*Specifications are subject to changes for improvement without advance notice.

Caution: This product specification is a TENTATIVE EDITION.

Its mechanical dimension, layout and electro-optical properties may be revised to improve product quality and reliability.